

EVERY BLIND PERSON

DESERVES TO MOVE AROUND FREELY IN PUBLIC



**WE MANUFACTURE
TACTILE TILE & BRAILLE SIGN**

MADE IN INDIA FOR THE WORLD.

signxpress.ae



 +971 544236234

 info@signxpress.ae

 CWS-2V-321545, 26th Floor, Amber Gem Tower, Sheikh Khalifa Street, Ajman, United Arab Emirates.



Who We Are

Signxpress is a leading manufacturer and supplier of accessibility and safety solutions, dedicated to building inclusive, barrier-free environments. With our headquarters in New Delhi, we serve clients across government, public, and private sectors in India and globally.

What We Do

We design, manufacture, and deliver a wide range of accessibility and safety products, including :

1. PU, PVC, SS & ABS Tactile Tiles
2. Tactile Studs & Directional Strips
3. Braille Signage (Acrylic, SS, MDF)
4. Lift Braille Labels & Wayfinding Signs
5. Stainless Steel Grab Bars & Accessible Hardware
6. Road Safety Products: Speed Breakers, Road Studs, Reflective Tapes,
7. Sign Boards
8. We also undertake end-to-end projects, from consultation and design to installation and after-sales support.

Why We Do It

We are driven by a commitment to accessibility, inclusion, and safety. In support of the our goal is to empower individuals with disabilities and improve public infrastructure to be usable by all.

We make an AE accessible & inclusive country for people with disability and make the public infrastructure more safer for everyone with Accessible Products.

At Signxpress AE, we're committed to providing organizations of all sizes and types with quality interior signage and Accessible Products. No matter what industry you're in, you can trust our team to help you with your next sign project and ensure the displays you order fit your unique needs.

Here are just some of the markets we serve:

- **Govt. & Private Projects** – We specialize in govt. and pvt. project execution excellence.
- **Sign Shops & Wholesale** – Become a wholesale partner or Braille signage reseller!
- **Contractor** – Take newly constructed and renovated buildings to the next level.
- **Elementary & High Schools** – Create an inclusive environment for all students.
- **Colleges & Universities** – Improve wayfinding and accessibility across campus.
- **Hotel** – Ensure the safety of guests while providing a welcoming atmosphere.
- **Apartment** – Develop a sense of community among residents in your complex.
- **Assisted Living** – Help make residents at your facility feel at home and at ease.
- **Health Care** – Simplify navigation for patients, new staff members, and visitors.
- **And more!**



International

01. Bhutan Convention Center - Bhutan
02. Unicef - Sri Lanka
03. Kuwait - Saudi Arab
04. Romania - UK
05. Poland - UK

Banks & Corporate Offices

01. ITC Green Center - Bengaluru
02. Amazon Warehouse - Manesar, HR
03. Nestle R&D Center - Manesar, HR
04. Reserve Bank of India - Mumbai
05. HDFC Banks - Vijaywada
06. PNB Banks - Delhi
07. Canera Banks - Chennai
08. SBI Banks - Arunachal Pradesh
09. DLF Downtown - Chennai
10. Vigyan Bhawan - Govt. of India, Delhi
11. Blind Relief Association - New Delhi
12. National Homeopathy - New Delhi

Govt. Hospitals

01. Guru Gobind Singh Hospital - New Delhi
02. G.B. Panth Hospital - New Delhi
03. RML Hospital - New Delhi
04. Delhi Govt. Dispensary 25 Centers - New Delhi

Judicial Courts

01. Supreme Court of India - New Delhi
02. Tis Hazari Court - New Delhi
03. District Court - Ahmedabad, Gujarat

Airport, Railways, Bus Stops, Metros

01. Namo Bharat Rail RRTS Delhi-Merrut
02. Delhi Shahdara Railway Station - Delhi
03. Beohari Railway Station - MP
04. Reva Railway Station - MP
05. Pipariya Railway Station - MP
06. Sheora Railway Station - MP
07. Jabalpur Railway Station - MP
08. Katni Railway Station - MP
09. Bus Stops - Saurashtra
10. Tuticorin Airport Project - Tamil Nadu
11. Ayodhya Airport - Uttar Pradesh]
12. NDMC Toilets
13. Chennai Metro Rail Corporation - Chennai

School, College, Institutes

01. IIT - Delhi
03. IIT - Kharagpur
04. DSIIDC Offices
05. PWD Guest House - Rewari
06. All PWD Schools - New Delhi
07. All PWD Hospitals - New Delhi
08. CPWD Community Center/Society
09. IAS office - Goa
10. Post office - Tamil Nadu
11. Maharaj Suraj Mal University - Bharatpur
12. Guru Teg Bahadur University - New Delhi
13. Post Office - Haryana
14. Post Office - Meghalaya
15. CBI Office -Jammu & Kashmir
16. Ministry of Social Justice and Empowerment - New Delhi

Advantage of PU Tactile Tiles



It is a state-of-the-art design **ground surface indicator for the vision impaired and the differently-abled**. This unique product is a very new concept in India and **it is ideal for use both in indoor and outdoor applications to create a barrier-free environment**. These tiles can be installed in minutes by peel-and-bond technology, but still provide long lasting solution. It is being manufactured as per **Dubai Universal Design Code**.

MATERIAL

The Tactile is Manufactured from 100% Virgin Certified TPU Material.

QUALITY

PU TACTILE TILE-STRIP-STUD are manufactured in Approved Standard Guidelines. Used strong & High-Quality self-adhesive ensures perfect bonding.

INSTALLATION METHOD



PU Tactile can be installed on any smooth surface by just peel and bond method i.e. just peel off the back side sticker and fix the tile on the floor firmly. The alignment should be checked properly while installing the tiles and there should not be any gap left in between the adjacent tiles. **Prior to the installation, it is necessary to make the surface level smooth and in order by attending repairs if any so that fixing of PU Tactile may be ensured by the technical team at site.**



COMPARISON BETWEEN CERAMIC AND PU TACTILE

Ceramic Tactile	Polyurethane Tactile
Non self adhesive	Self Adhesive
Installation takes a lot of time	Installation is very quick
Color fades away	No color fading
Less color availability	Available in different colours
Feels hard	Feels soft
Prone to crack	Crack will not rise
Less friction	Very high friction
Low luminance contrast	High luminance contrast
Can be Installed only on chipped surface	Can be install on any surface metal, wooden, concrete, granite etc.

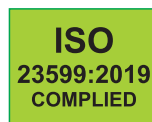

PRODUCT DATA

Parameters	Specifications
Dimensions	300 mm X 300 mm
Product weight	300 g Appx
ISO 23599-2019	Compliant
Materials	Polyurethane
UV Stability	Yes
Warranty	5 years
Life Expectancy	7-10 years
Indoor use	Yes
Outdoor use	Yes
Adhesive	Tissue or Butyl d/s tape

APPLICATIONS

(Under salient features of the rights of persons with disabilities act, 2016 section 40 to 46)

**RAMPS ● BUS STOPS ● CAR PARKS ● ZEBRA CROSSINGS ● RAILWAY PLATFORMS
ESCALATOR ENTRANCES ● SCHOOLS ● HOSPITALS ● OVERHEAD HAZARDS ● TOILET
STAIRWAYS ● SWIMMING POOL ● LIFT ENTRANCE ● DOOR ENTRANCE ● FIRE ESCAPES**

DISADVANTAGE OF CERAMIC TACTILE TILES



Prone to crack



Feels hard



Low luminance contrast



Less color availability



Color fades away



Can be Installed only on chipped surface



Installation takes a lot of time



Non self adhesive

**REPLACE TODAY WITH SIGNXPRESS
ABS TACTILE TILE 7MM TO 60MM AVAILABLE**



PU TACTILE TILES STRIPS AND STUDS



ISO 23599 COMPLIANT

PU TACTILE TILE – 001

PUTT 001A
PUTT 001B
PUTT 001C

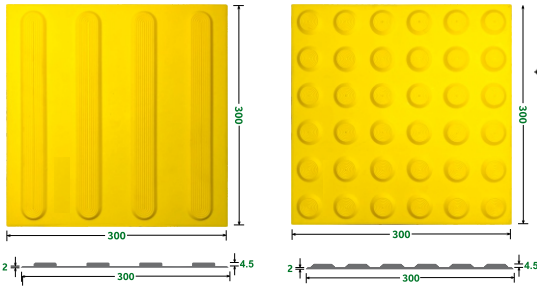

TISSUE TAPE HIGH BOND TAPE

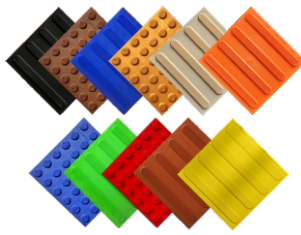

Peel & Paste

- Dimensions : 300 x 300 x 7 mm
- Raw Material : Polyurethane UV Stabilized & Stain Resistant
- Tile Pattern : Anti-skid Concentric / Linear Pattern
- Self-adhesive Tape : 140µ Tissue Tape
- Suitable Substrates : Stone / Masonry / Timber / Vitrified / Glass / Metals
- Fixing : Peel & Paste (No Civil Work required)

TISSUE TAPE BEST FOR INDOOR

ONLY FOR DRY & SMOOTH SURFACES
STONE, TIMBER, VITRIFIED, GLASS

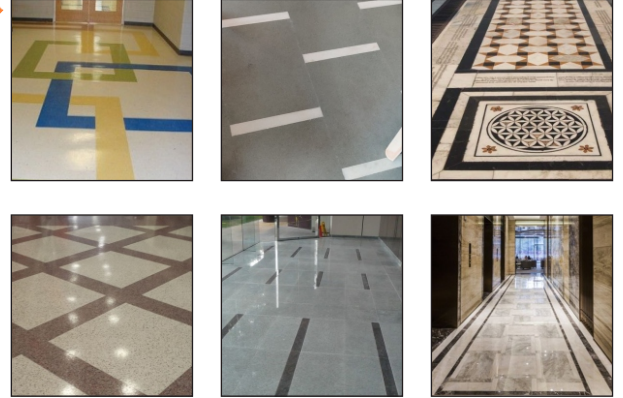

PU TACTILE TILE WITH WASHER – 002

PUTT 002A
PUTT 002B
PUTT 002C

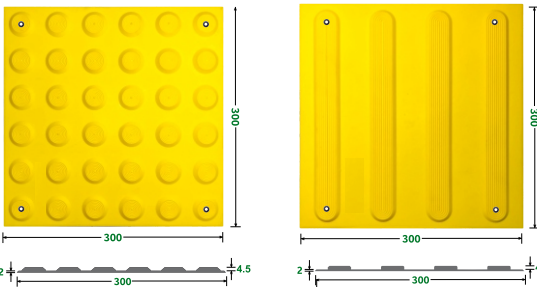

BUTYL TAPE SCREW



Peel & Paste

- Dimensions : 300 x 300 x 7 mm
- Raw Material : Polyurethane UV Stabilized & Stain Resistant
- Tile Pattern : Anti-skid Concentric / Linear Pattern
- Self-adhesive Tape : 1mm Butyl Rubber Tape
- Suitable Substrates : Stone / Masonry / Timber / Vitrified / Glass / Metals
- Fixing : Peel & Paste (No Civil Work required)

BUTYL TAPE+ SCREW BEST FOR OUTDOOR

DRILL & FIXED GETS STRONG FIXING
DRY SURFACES
RCC, KOTA, CEMENT



ABS TACTILE TILE 25 MM CAST IN PLACE – 007

ABSTT 007A

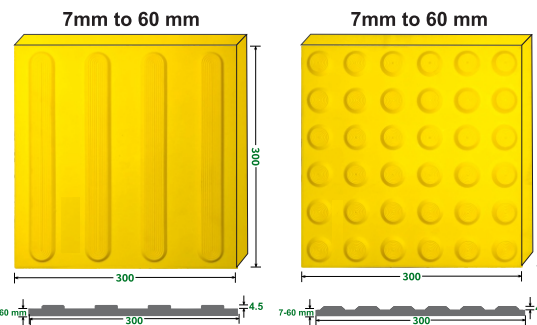

ABS TACTILE NEVER CRACKED NEVER COLOR FADE 100% COMPLIANCE

- Dimensions : 300 x 300 x 7-60 mm
- Raw Material : UV Stabilized & Stain Resistant
- Tile Pattern : Anti-skid Concentric / Linear Pattern
- Suitable Substrates : Paver Blocks, Bitumen Road, RCC Roads
- Fixing : Filled With Cement, Concrete Mixture

ABS TACTILE BEST FOR PATHWAY

FILLED WITH CONCRETE
PAVER BLOCKS, RCC-BITUMEN ROADS
FOR STRONG LONG LASTING RESULT



REPLACE WITH
EXCITING
CERAMIC TILES

PU TACTILE STRIP – 008

STEM

PUTSTR 008D

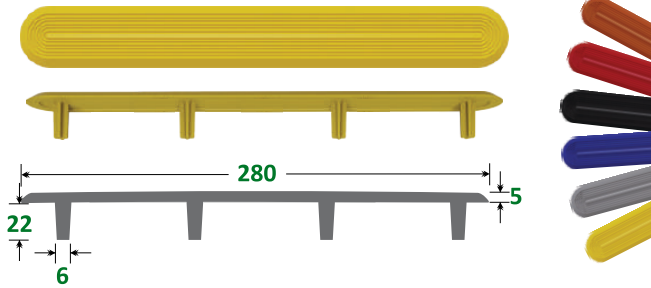

Dimensions : 280 x 35 x 5 mm / Stem 22 mm
 Raw Material : Polyurethane UV Stabilized & Stain Resistant
 Self-adhesive : 140µ Tissue Tape / 4 Stems
 Strip Pattern : Strip with Anti-skid Linear Pattern
 Suitable Substrates : Stone / Masonry / Timber / Vitrified / Glass / Metals
 Fixing : Peel & Paste (No Civil Work required) / 4 Stems drill & fix

PU TACTILE STRIP – 008

SELF-ADHESIVE

PUTSTR 008A
 PUTSTR 008B
 PUTSTR 008C

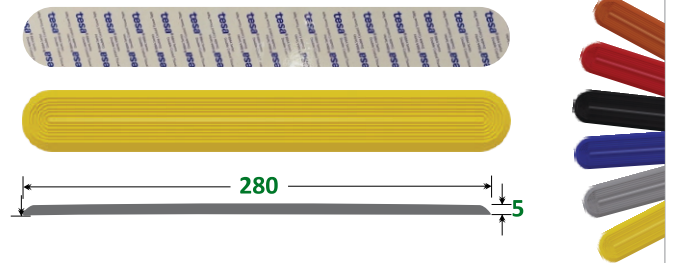

Dimensions : 280 x 35 x 5 mm / Stem 22 mm
 Raw Material : Polyurethane UV Stabilized & Stain Resistant
 Self-adhesive : 140µ Tissue Tape / 4 Stems
 Strip Pattern : Strip with Anti-skid Linear Pattern
 Suitable Substrates : Stone / Masonry / Timber / Vitrified / Glass / Metals
 Fixing : Peel & Paste (No Civil Work required) / 4 Stems drill & fix

PU TACTILE STUD – 009

STEM

PUTSTD 009D

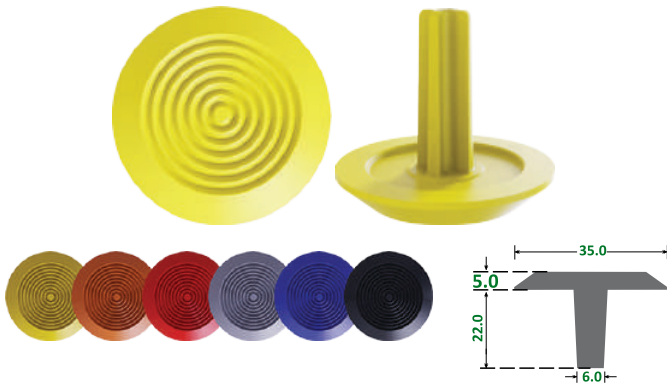

Dimensions : 35 x 5 mm / Stem 22 mm
 Raw Material : Polyurethane UV Stabilized & Stain Resistant
 Self-adhesive : 140µ Tissue Tape / 1 Stems
 Stud Pattern : Stud with Anti-skid Concentric Rings Pattern
 Suitable Substrates : Stone / Masonry / Timber / Vitrified / Glass / Metals
 Fixing : Peel & Paste (No Civil Work required) / 1 Stem drill & fix

PU TACTILE STUD – 009

SELF-ADHESIVE

PUTSTD 009A
 PUTSTD 009B
 PUTSTD 009C

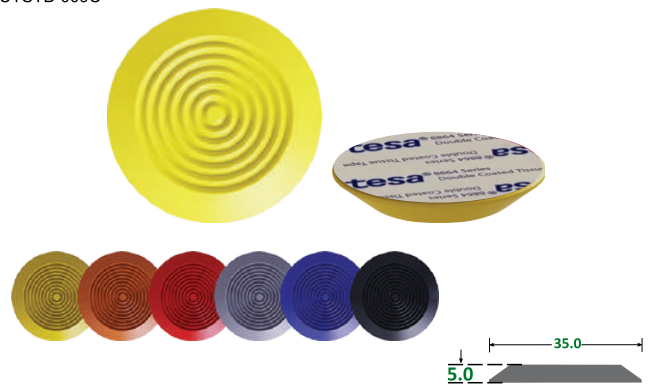

Dimensions : 35 x 5 mm / Stem 22 mm
 Raw Material : Polyurethane UV Stabilized & Stain Resistant
 Self-adhesive : 140µ Tissue Tape / 1 Stems
 Stud Pattern : Stud with Anti-skid Concentric Rings Pattern
 Suitable Substrates : Stone / Masonry / Timber / Vitrified / Glass / Metals
 Fixing : Peel & Paste (No Civil Work required) / 1 Stem drill & fix



SCHOOLS

OFFICES

HOTELS

HOSPITALS

SS Tactile Tile – 010 SLD

#SOLID

Premium Quality Heavy Duty

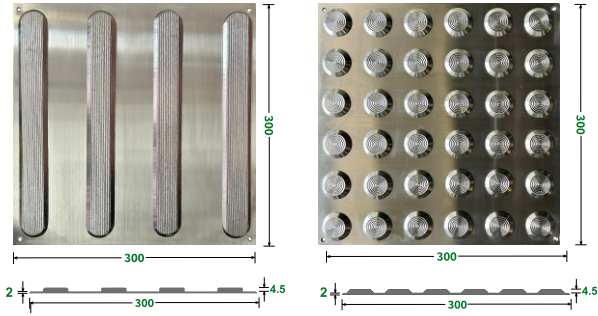

Dimensions : 300 x 300 x 2 mm
 Raw Material : Stainless Steel 304 & 316 Grade
 Tile Pattern : Anti-skid Concentric / Linear Pattern
 Suitable Substrates : Stone / Masonry / Timber / Vitrified / Glass / Metals
 Fixing : Drill and Screw

SS Tactile Tile – 010 SHT

#SHEET

Affordable Light Weight

Coming Soon

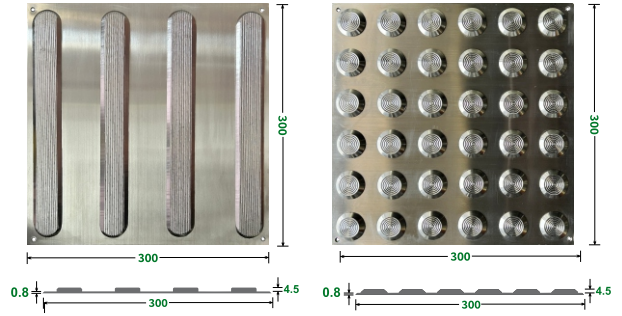

Dimensions : 300 x 300 x 0.8 mm
 Raw Material : Stainless Steel 304 & 316 Grade
 Tile Pattern : Anti-skid Concentric / Linear Pattern
 Suitable Substrates : Stone / Masonry / Timber / Vitrified / Glass / Metals
 Fixing : Drill and Screw

SS Tactile Tile – 011 SLD

#SOLID

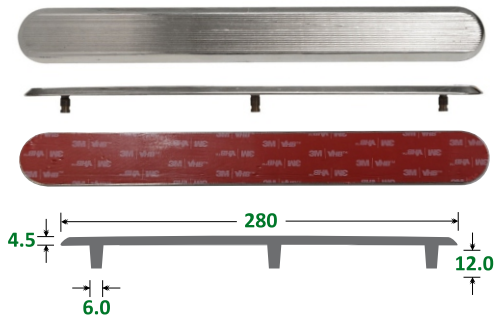

Dimensions : 280 x 35 x 4.5 mm / Stem 12 mm
 Self-adhesive : 3M VHB Tape / 3 Stems
 Strip Pattern : Strip with Anti-skid Linear Pattern
 Suitable Substrates : Stone / Masonry / Timber / Vitrified / Glass / Metals
 Fixing : Peel & Paste (No Civil Work required) / 3 Stems drill & fix

SS Tactile Tile – 011 SHT

#SHEET

Coming Soon

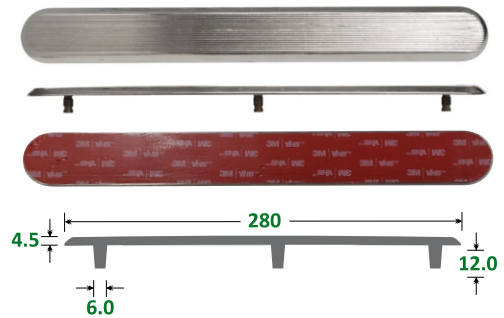

Dimensions : 280 x 35 x 4.5 mm / Stem 12 mm
 Self-adhesive : 3M VHB Tape / 3 Stems
 Strip Pattern : Strip with Anti-skid Linear Pattern
 Suitable Substrates : Stone / Masonry / Timber / Vitrified / Glass / Metals
 Fixing : Peel & Paste (No Civil Work required) / 3 Stems drill & fix

SS Tactile Stud – 015 SLD

#SOLID

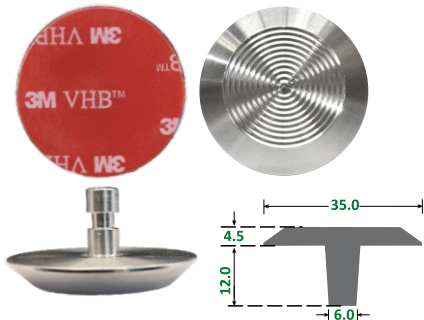

Dimensions : 35 x 4.5 mm / Stem 12 mm
 Self-adhesive : 3M VHB Tape / 1 Stems
 Tile Pattern : Stud with Anti-skid Concentric Rings Pattern
 Suitable Substrates : Stone / Masonry / Timber / Vitrified / Glass / Metals
 Fixing : Peel & Paste (No Civil Work required) / 1 Stem drill & fix

SS Tactile Stud – 015 SHT

#SHEET

Coming Soon

Filled With
Epoxy Hardener

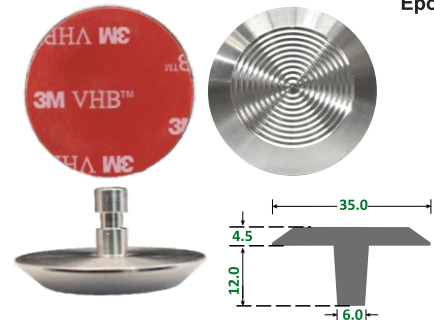

Dimensions : 35 x 4.5 mm / Stem 12 mm
 Self-adhesive : 3M VHB Tape / 1 Stems
 Tile Pattern : Stud with Anti-skid Concentric Rings Pattern
 Suitable Substrates : Stone / Masonry / Timber / Vitrified / Glass / Metals
 Fixing : Peel & Paste (No Civil Work required) / 1 Stem drill & fix

Acrylic Braille Sign – 101



BRL-ACR-101-A

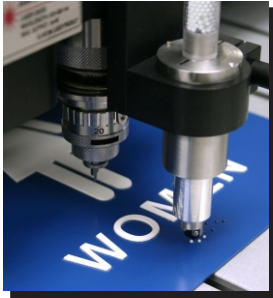

Specifications : Base: 4 mm Letters: 1 mm
 Raw Material : A-cast Matt Finish Acrylic Sheet
 Standard Sizes : 150x230, 200x200, 450x450 (mm) & customized
 Braille Dots : 1.5 mm SS 304 Grade
 Fixing : Peel & Paste / Screw
 Colours Available : 

Stainless Steel Braille Sign – 102



BRL-SS-102



Specifications : 0.5 mm 304 Grade Matt Finish
 Standard Sizes : 150x230, 200x200, 450x450 (mm) & customized
 Braille Dots : 1.5 mm SS 304 Grade
 Fixing : Peel & Paste / Screw
 Colours Available : 

Aluminium Braille Sign – 103



BRL-ALU-103



Specifications : Base: 3 mm Letters: 2 mm
 Raw Material : Matt Finish Paper Board
 Standard Sizes : 150x230, 200x200, 450x450 (mm) & customized
 Braille Dots : 1.5 mm SS 304 Grade
 Fixing : Peel & Paste / Screw
 Colours Available : 

MDF Braille Sign – 104



BRL-MDF-104



Specifications : Base: 3 mm Letters: 3 mm
 Raw Material : Mdf Laminated
 Standard Sizes : 150x230, 200x200, 450x450 (mm) & customized
 Braille Dots : 1.5 mm SS 304 Grade
 Fixing : Peel & Paste / Screw
 Colours Available : 

Glow-in-Dark Braille Sign – 106



BRL-GID-106



Specifications : Base 3mm
 Raw Material : Night Glow Sheet
 Standard Sizes : 150x230, 200x200, 450x450 (mm) & customized
 Braille Dots : 1.5 mm SS 304 Grade
 Fixing : Peel & Paste / Screw
 Colours Available : 

Railing Braille Sign – 107



BRLRS-SS-107A
 BRLRS-AL-107B

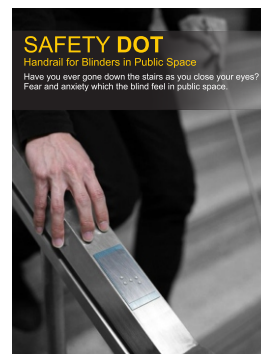



Specifications : 0.5 mm 304 Grade Matt Finish
 Standard Sizes : 200x50 (mm) & customized
 Braille Dots : 1.5 mm SS 304 Grade
 Fixing : Peel & Paste / Screw
 Colours Available : 

Stainless Steel Tactile Map – 109 

BRL-SSTM-109



Specifications : 1mm Thick
 Raw Material : Made Of SS Material
 Standard Sizes : 4x3, 3*2 feet
 Braille Dots : Raised Braille
 Fixing : Peel & paste / Screw
 Colours Available : 

Acrylic Audio Braille Sign – 111 

BRL-AAS-111





Specifications : Audio Option
 Raw Material : Acrylic
 Standard Sizes : 300*450 mm
 Braille Dots : 1.5 mm SS 304 Grade
 Fixing : Peel & paste / Screw
 Colours Available : 

Stainless Steel Braille Sign – 102

BRL-ALU-103





Specifications : 0.5 mm 304 Grade Matt Finish
 Standard Sizes : Customized
 Braille Dots : 1.5 mm SS 304 Grade
 Fixing : Peel & Paste
 Colours Available :  

Stainless Steel Braille Labels – 112

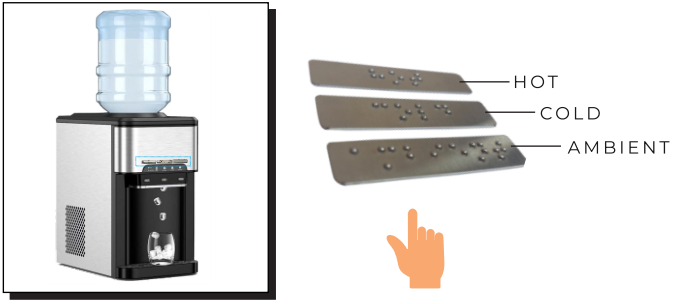
BRL-SS-LBL-112



Specifications : 0.5 mm 304 Grade Matt Finish
 Standard Sizes : Customized
 Braille Dots : 1.5 mm SS 304 Grade
 Fixing : Peel & Paste
 Colours Available :  

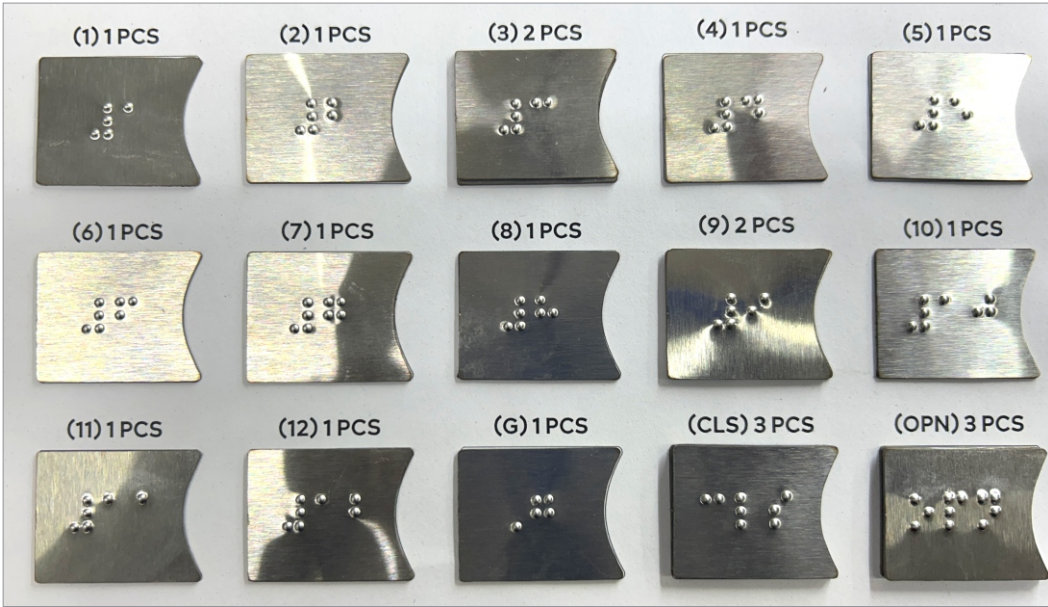



ATM BRAILLE BUTTON & SIGNAGES



Stainless Steel Braille Sign – 102

BRL-ALU-103

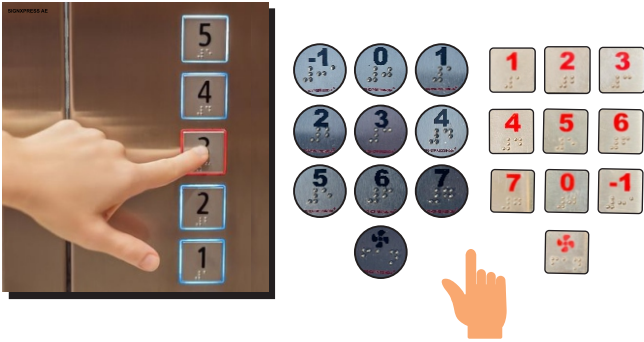

- Specifications : 0.5 mm 304 Grade Matt Finish
- Standard Sizes : 20 X 20 (mm) & customized
- Braille Dots : 1.5 mm SS 304 Grade
- Fixing : Peel & Paste
- Colours Available :



Aluminium Braille Sign – 103

BRL-ALU-103



- Specifications : 0.5 mm 304 Grade Matt Finish
- Standard Sizes : 6X2 inch & customized
- Braille Dots : 1.5 mm SS 304 Grade
- Fixing : Peel & Paste
- Colours Available :



Audio Tactile Braille Map – 110

BRL-AUDTM-110

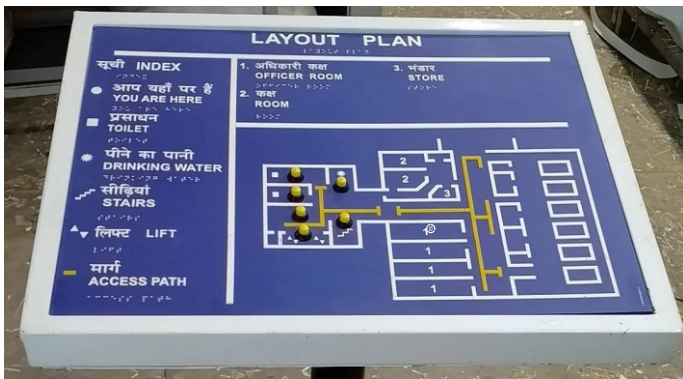

- Dimensions : 48x36 inch (Customize)
- Material : Acrylic
- Base : 4mm
- Power Supply : AC/DC



ATM Braille Labels – 114

BRL-LBL-114



- Specifications : 0.5 mm 304 Grade Matt Finish
- Standard Sizes : 20X15 (mm) & customized
- Braille Dots : 1.5 mm SS 304 Grade
- Fixing : Peel & Paste
- Colours Available :



BEFORE

AFTER



WITHOUT BRAILLE

WITH BRAILLE

Explore the world through fingertips

Getting the custom interior **BRAILLE SIGNS** you need is simple. We apply a 3-step process that streamlines your order while ensuring you're involved from start to finish.

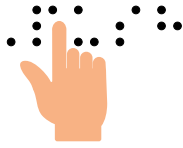

Quality and Compliant Signage with a Speedy Turnaround

Quick Ship Signs Available for Shipping in Pan India
 Orders of less than 15 signs 1-2 business days
 15 to 40 signs 3-4 business days
 Over 40 signs 5 business days
 Free Shipping Delhi/NCR only



Step 1:

Quoting



Email our sales team at info@signxpressindia.com with specifications for your sign project. The more detail you provide, the better!

Step 2:

Proofing



After we've received confirmation that you have approved the quote provided, the order will then be moved into the graphics queue.

Step 3:

Production

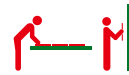

The graphics team will then get your order set up for production and send it to the "floor" where the production team will take over.

PANIC ALARM 302

PA-302A

EMERGENCY BELL CORDLESS



PUSH BUTTON TALKING BRAILLE SIGNAGE

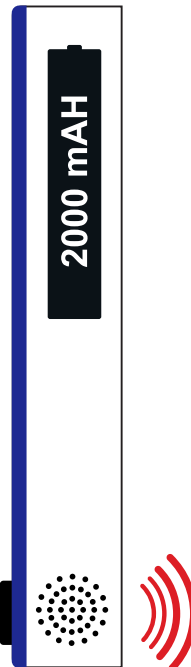

EMERGENCY BELL CORDLESS



ANNOUNCEMENT SIGNAGE



If your building is open to the public, you must comply with braille signage and make the building accessible friendly for person with disability.
(Under salient features of the rights of persons with disabilities act, 2016 section 40 to 46)

Did You Know?

Acrylic Braille Sign – 101



Acrylic Braille Sign – 101



Acrylic Braille Sign – 101



Acrylic Braille Sign – 101



SS Braille Sign – 102



SS Braille Sign – 102



SS Braille Sign – 102



SS Braille Sign – 102



Aluminium Braille Sign – 103



Aluminium Braille Sign – 103



Aluminium Braille Sign – 103



Aluminium Braille Sign – 103



MDF Braille Sign – 104



MDF Braille Sign – 104

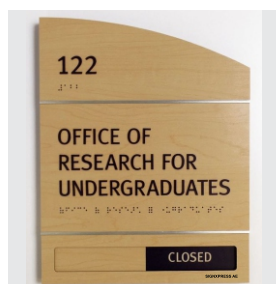

MDF Braille Sign – 104



MDF Braille Sign – 104



Model No.: SIGB 01

Straight Grab Bar

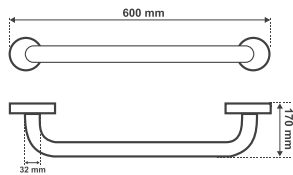

Material	SS-304 Grade
Dimensions	600 x 32 mm
Application	WC Area
Size	600 mm
Fixing	Drill & Fix with Screw

Model No.: SIGB 02

Swing Grab Bar

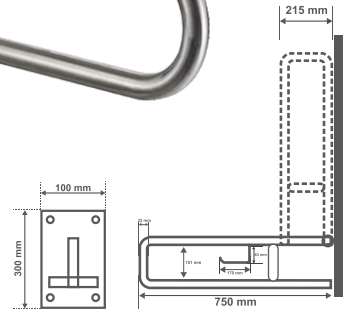

Material	SS-304 Grade
Dimensions	750 x 215 x 300 x 100 mm
Application	WC Area
Size	750 mm
Fixing	Drill & Fix with Screw

Model No.: SIGB 03

U-Shaped Grab Bar

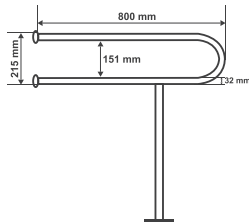

Material	SS-304 Grade
Dimensions	800 x 215 mm
Application	WC Area
Size	800 mm
Fixing	Drill & Fix with Screw

Model No.: SIGB 04

L Shaped Grab Bar

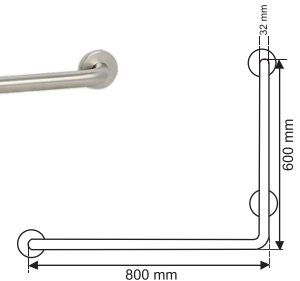

Material	SS-304 Grade
Dimensions	600 x 600 mm
Application	WC Area
Size	600 mm
Fixing	Drill & Fix with Screw

Model No.: SIGB 05

Urinal Safety Steel Grab Bar

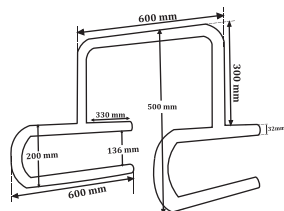
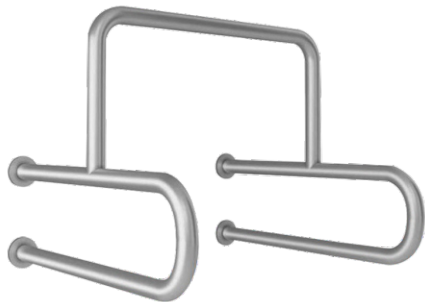

Material	SS-304 Grade
Dimensions	600 x 32 mm
Application	Urinal Area
Size	600 mm
Fixing	Drill & Fix with Screw

Signxpress
Stainless Steel Grab Bar
 offers sturdy support and safety in various settings. Crafted from durable stainless steel, it ensures reliability and longevity, ideal for bathrooms, hospitals, and public facilities.

OUR PRODUCTS

- ✓ Pu Tactile Tiles Self-Adhesive Tape
- ✓ Stainless Steel Tactile Tiles Self-Adhesive Tape
- ✓ Acrylic Braille Signage & Tactile Map
- ✓ Stainless Steel Braille Signage & Tactile Map
- ✓ Grab Bars & Accessible Products
- ✓ Braille Labels & Braille Buttons



Corporate Office:

CWS-2V-321545, 26th Floor, Amber Gem Tower, Sheikh Khalifa Street, Ajman, United Arab Emirates.

Website:

www.signxpress.ae

ISO Certifications: ISO: 23599:2019, ISO: 14001:2015, ISO: 9001:2015

Contact:

Landline: +971 68088888 - PO Box 4848

Email:

info@signxpress.ae

Feedback & Suggestions:

+91 9810032137

Follow us:



Note: Any information given in this catalogue is to the best of our knowledge. Any dimension/design is subject to change without prior notice E&OE

